

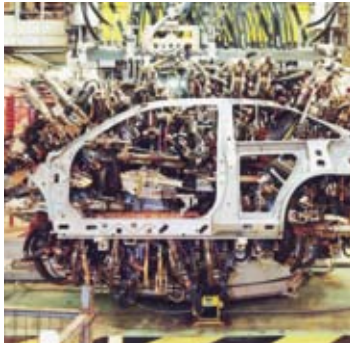

aerospace
climate control
electromechanical
filtration
fluid & gas handling
hydraulics
pneumatics
process control
sealing & shielding



Directional Control Valves

Series VA13 and VA15

3- and 5-port valves. G1/8

Catalogue PDE2617TCUK. Edition June 09



ENGINEERING YOUR SUCCESS.

Directional control valves

Working medium, air quality

Working medium: Dry, filtered compressed air to ISO 8573-1 class 3.4.3.

Recommended air quality

For best possible service life and trouble free operation, ISO 8573-1 quality class 3.4.3 should be used. This means 5µm filter (standard filter) dew point +3°C for indoor operation (a lower dew point should be selected for outdoor operation) and oil concentration 1.0 mg oil/m³, which is what a standard compressor with a standard filter gives.

Compact installation dimensions - flexible installation



The VA13/15 valve range consists of spool valves of extremely robust design, incorporating a wide range of manual, mechanical and pilot-operated actuators.

Rust and corrosion resistant designs.

The valve bodies and caps are made of brass. Stainless steel is used in the spools and the mechanical actuating devices. Versions intended for panel mounting have chromium-plated steel actuators and panel bezels.

Mobile applications



The robust design, coupled with good corrosion resistance, makes the valves suitable for a wide range of applications. Manually operated valves are suitable for industrial and transport applications. The stable and ergonomically designed actuators make the valves easy to operate even with heavy working gloves.

ISO 8573-1 quality classes

Quality class	Pollution		Water max. press. dew point (°C)	Oil max. concentration (mg/m ³)
	particle size (µm)	max. concentration (mg/m ³)		
1	0,1	0,1	-70	0,01
2	1	1	-40	0,1
3	5	5	-20	1,0
4	15	8	+3	5,0
5	40	10	+7	25
6	-	-	+10	-

High reliability

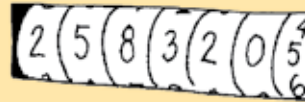

Valves easily comply with the requirements for component reliability in accordance with EU Machinery Directive standards EN292-2 and EN983.

The VA valves have few moving parts combined with short spool movement, these features combine to give valves having high reliability and long service life. The valves are designed for use with or without supplementary lubrication.

Maintenance

When maintenance is required repair kits containing replacement seals are available. See page 15

Directional control valves

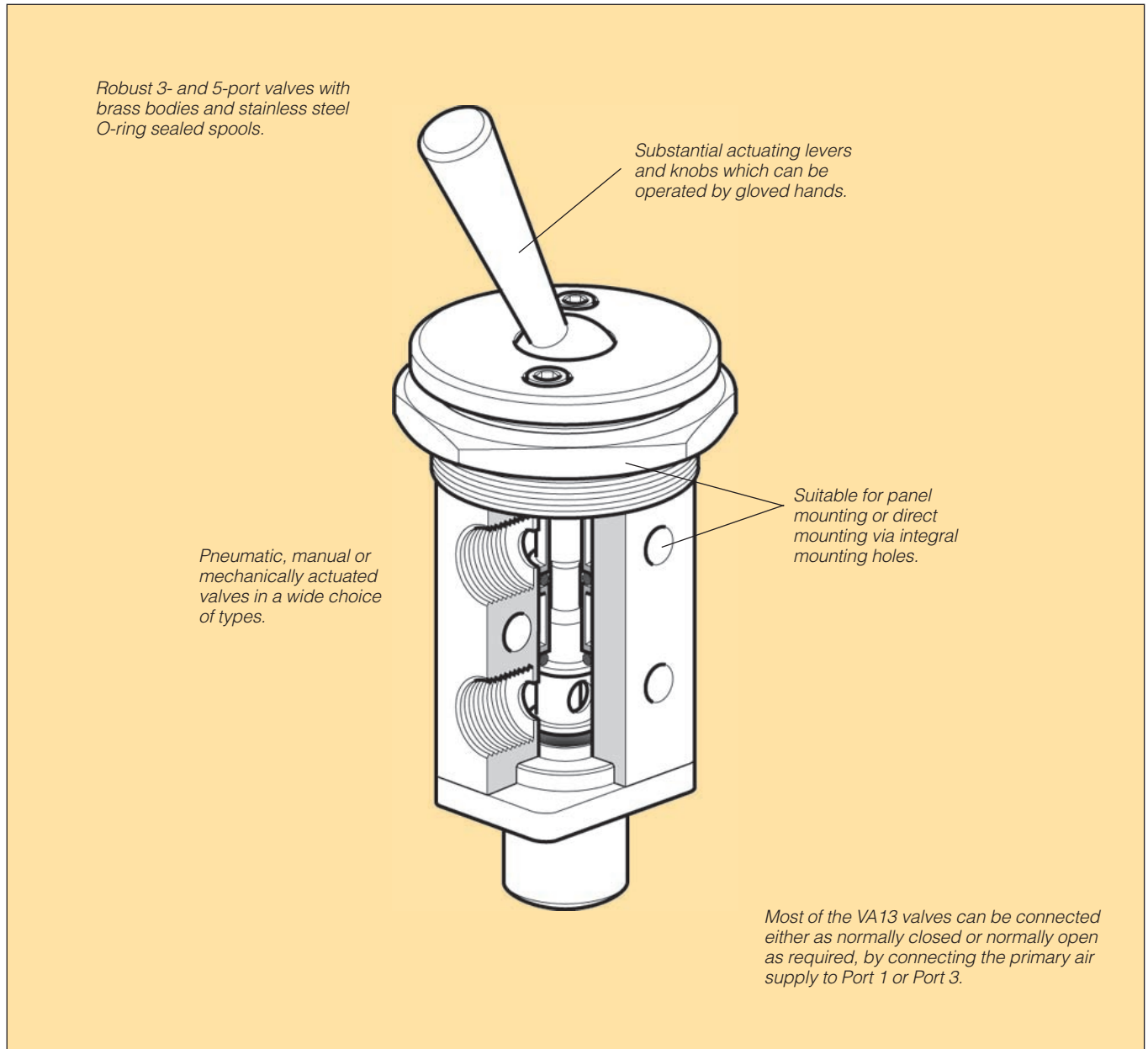

Ordering example **VA13-HIS4**

Valve type, VA _____

Valve size 1 = G1/8 _____

Number of ports, 3 or 5 _____

Type of actuation _____

Type of return _____

Type of installation _____

4 = panel mounted _____



Products specially suitable for the transport industry.

Directional control valves

Installation

Correctly mounted valves require only a minimum of maintenance. For maximum life, follow the instructions with regard to actuation directions, actuation speeds, angles and adjustments.

Panel mounting

Mount the valves in a 40,5 mm diameter hole (thread M40 x 1,5). The panel-mounting collars have a flange on the front of the panel and a retaining nut behind the panel, for simple installation and clean and attractive appearance.

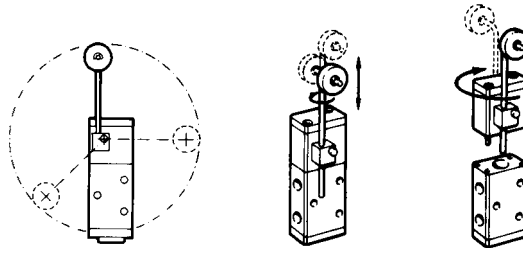

Fitting adjustable roller actuators

The rest position of the actuating arm can be arranged at any required angle on the actuator shaft (360°).

The length of the arm is adjustable, and it can also be rotated through 180°. Note, however, that the roller must always be parallel to the valve body.

The arm can also be positioned on the other side of the valve by removing the actuating mechanism, turning it through 180° and reassembling it.

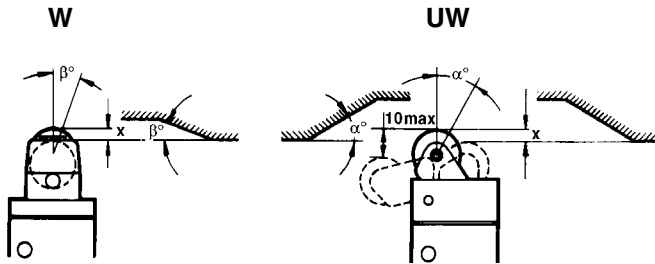

Actuation

Maximum actuation distance (X), i.e. the maximum spool stroke length, is 4 mm. Valves are fully open after 3,5 mm travel. Type UW toggle cam actuators permit a vertical motion in toggle direction of up to 10 mm.

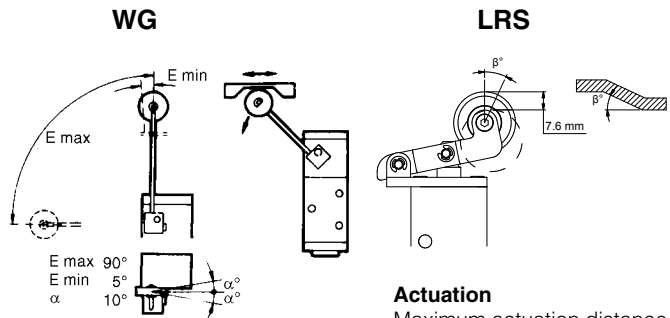

Actuation

Maximum actuation distance, the maximum spool stroke length is 7.6 mm.

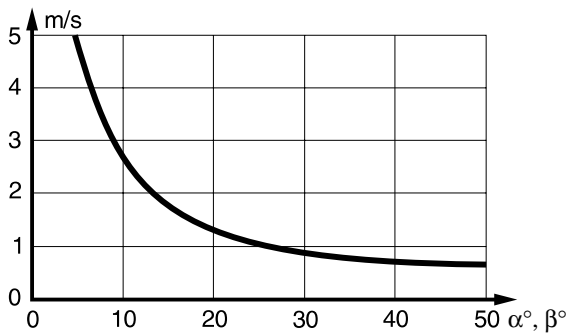

Actuation speed as a function of actuation angle

Optimum valve life will be obtained if the shape of actuation cams is matched to the method of actuation employed. The principle is that the higher the speed of the actuating motion, the smaller the incident angle. The characteristic curve shown here plots the incident angle against speed of the actuating stroke.

Actuation by adjustable roller

Actuation can be arranged in both directions if the arm is set as shown above. The arm needs to be moved through only 5° to make the valve change over, although a travel range of up to 90° can be accepted.

Material specifications

Valve bodies, end covers,	Brass
spring guides	Polished stainless steel
Spools	Nitrile rubber
Seals	Zinc plated steel
Screws, nuts, washers	Steel
Balls	Acetal plastic
Push-buttons, knobs	Chrome-plated steel
Levers	Phosphatized cast-iron
Pedals	Hardened stainless steel
I-plunger	Acetal plastic
Rollers	

IMPORTANT



Before servicing, make sure that the valve is depressurised. Disconnect the primary air hose to ensure that the air supply is safely interrupted before removing valves.

Data

Working temperature:	-20 °C to +70 °C
Working pressure:	max 10 bar
Flow (acc. to ISO 6358)	
C:	0,9 NI/s, bar
Qn (P1=6 bar, Δp=1 bar):	3,6 l/s
Qmax:	6,3 l/s
Cv:	0,21

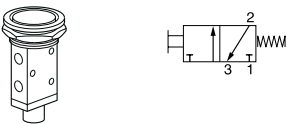
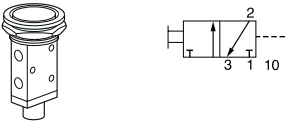
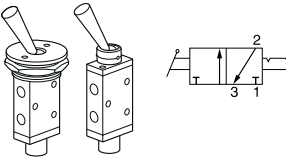
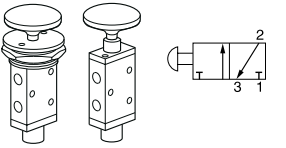
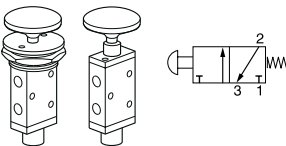
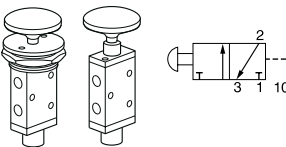
Symbol	Actuator	Return	Mounting	Changeover force at 6 bar	Weight kg	Order code
	Push-button Red	Spring	Panel mounted	32,5 N	0,37	VA13-HIS4
	Push-button Black	Spring	Panel mounted	32,5 N	0,37	VA13-HIS4A06*
	Push-button Red	Air signal	Panel mounted	6 N**	0,37	VA13-HIA4
	Hand lever Held in two positions	Hand lever	Panel mounted	8 N	0,52	VA13-HB24
		Hand lever	Side mounted	8 N	0,35	VA13-HB2
	Knob Red Two positions	Knob	Panel mounted	3 N	0,48	VA13-KL24
		Knob	Side mounted	3 N	0,31	VA13-KL2
	Knob Red	Spring	Panel mounted	31,5 N	0,49	VA13-KS4
		Spring	Side mounted	31,5 N	0,32	VA13-KS
	Knob Red Two positions	Knob/ Air signal	Panel mounted	6 N**	0,49	VA13-KL2A4
		Knob/ Air signal	Side mounted	6 N**	0,33	VA13-KL2A

* Panel holder in black anodized aluminium.

** Without signal pressure. Signal pressure min 3 bar at 6 bar supply pressure.



All VA13 valves (except VA13-WGR and VA13-RWG) can be connected either as normally closed 3/2 valve (NC) or normally open 3/2 valve (NO) as required, by connecting the primary air supply to Port 1 or Port 3.

Data

Working temperature: -20 °C to +70 °C
 Working pressure: max 10 bar
 Flow (acc. to ISO 6358)
 C: 0,9 Nl/s, bar
 Qn (P1=6 bar, Δp=1 bar): 3,6 l/s
 Qmax: 6,3 l/s
 Cv: 0,21

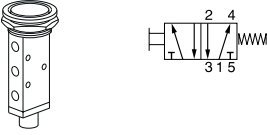
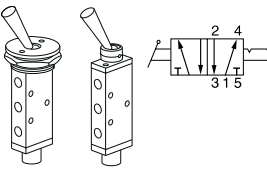
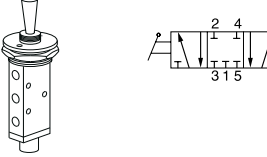
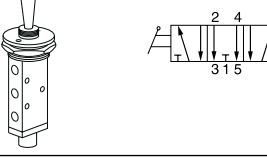
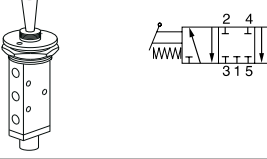
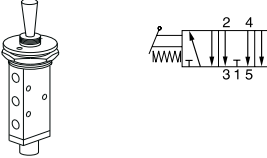
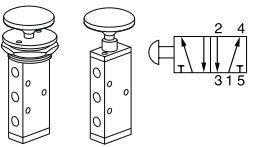
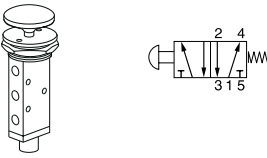
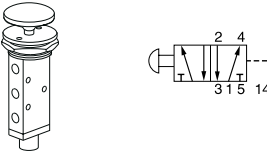
Symbol	Actuator	Return	Mounting	Changeover force at 6 bar	Weight kg	Order code
	Push-button Red	Spring	Panel mounted	34,5 N	0,46	VA15-HIS4
	Hand lever Held in two positions	Hand lever	Panel mounted	9 N	0,63	VA15-HB24
			Side mounted	9 N	0,45	VA15-HB2
	Hand lever Held in three positions	Hand lever	Panel mounted Closed centre position	9 N	0,63	VA15-HB34
	Hand lever Held in three positions	Hand lever	Panel mounted Exhausted centre position	9 N	0,63	VA15-XHB34
	Hand lever Three positions self-centring	Hand lever	Panel mounted Closed centre position	9 N	0,63	VA15-HC4
	Hand lever Three positions self-centring	Hand lever	Panel mounted Exhausted centre position	9 N	0,63	VA15-XHC4
	Knob Red Two positions	Knob	Panel mounted	5 N	0,58	VA15-KL24
			Side mounted	5 N	0,42	VA15-KL2
	Knob Red	Spring	Panel mounted	34,5 N	0,60	VA15-KS4
	Knob Red Two positions	Knob/Air signal	Panel mounted	8 N*	0,61	VA15-KL2A4

*Without signal pressure. Signal pressure min 3 bar at 6 bar supply pressure.

Data

Working temperature: -20 °C to +70 °C
 Working pressure: max 10 bar
 Flow (acc. to ISO 6358)
 C: 0,9 NI/s, bar
 Qn (P1=6 bar, Δp=1 bar): 3,6 l/s
 Qmax: 6,3 l/s
 Cv: 0,21

VA13

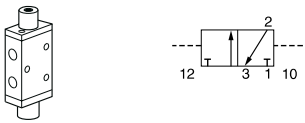
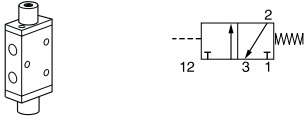
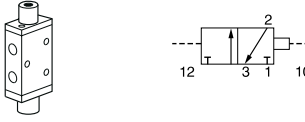



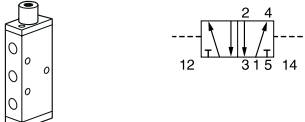
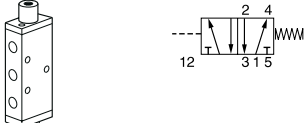
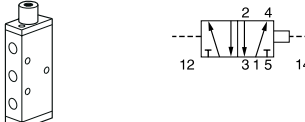

Symbol	Actuator	Return	Mounting	Signal pressure min, bar at 6 bar actu./return	Weight Kg	Order code
	Air signal	Air signal	Side mounted	3/3	0,33	VA13-AA
	Air signal	Spring	Side mounted	4/-	0,32	VA13-AS
	Air signal with priority	Air signal	Side mounted	3/4	0,32	VA13-ADA

VA15

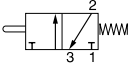
Symbol	Actuator	Return	Mounting	Signal pressure min, bar at 6 bar actu./return	Weight Kg	Order code
	Air signal	Air signal	Side mounted	3/3	0,33	VA15-AA
	Air signal	Spring	Side mounted	4/-	0,32	VA15-AS
	Air signal with priority	Air signal	Side mounted	3/4	0,32	VA15-ADA

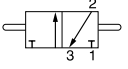
Data

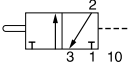
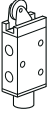
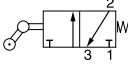
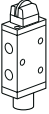
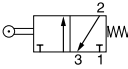
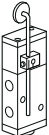
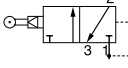
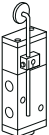
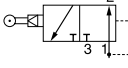
Working temperature: -20 °C to +70 °C
 Working pressure: max 10 bar
 max 8 bar for WGR and RWG
 Flow (acc. to ISO 6358)
 C: 0,9 NI/s, bar
 Qn (P1=6 bar, Δp=1 bar): 3,6 l/s
 Qmax: 6,3 l/s
 Cv: 0,21

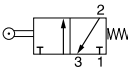
	Symbol	Actuator	Return	Mounting	Changeover force at 6 bar	Weight kg	Order code
		Plunger	Spring	Side mounted	32,5 N	0,30	VA13-IS
		Plunger Two positions	Plunger	Side mounted	3 N	0,30	VA13-II
		Plunger	Air signal	Side mounted	6 N*	0,30	VA13-IA
		Roller one way trip	Spring	Side mounted	20,5 N	0,33	VA13-UWS
		Roller	Spring	Side mounted	32,5 N	0,33	VA13-WS
		Roller on an arm	Internal air min 4 bar	Side mounted Normally closed	0,6 N min	0,41	VA13-WGR
		Roller on an arm	Internal air min 4 bar	Side mounted Normally open	0,6 N min	0,41	VA13-RWG
		Roller	Spring	Side mounted		0,41	VA13-LRS





* Without signal pressure. Signal pressure min 3 bar at 6 bar supply pressure.

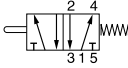

All VA13 valves (except VA13-WGR and VA13-RWG) can be connected either as normally closed 3/2 valve (NC) or normally open 3/2 valve (NO) as required, by connecting the primary air supply to Port 1 or Port 3.

Data

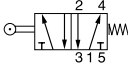
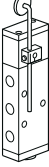
Working temperature: -20 °C to +70 °C
 Working pressure: max 10 bar
 max 8 bar for WGR
 Flow (acc. to ISO 6358)
 C: 0,9 NI/s, bar
 Qn (P1=6 bar, Δp=1 bar): 3,6 l/s
 Qmax: 6,3 l/s
 Cv: 0,21

	Symbol	Actuator	Return	Mounting	Changeover force at 6 bar	Weight kg	Order code
		Plunger	Spring	Side mounted	34,5 N	0,40	VA15-IS
		Plunger Two positions	Plunger	Side mounted	5 N	0,40	VA15-II
		Roller one way trip	Spring	Side mounted	21,6 N	0,43	VA15-UWS
		Roller	Spring	Side mounted	34,5 N	0,44	VA15-WS
		Roller on an arm	Internal air min 4 bar	Side mounted	0,6 N min	0,46	VA15-WGR
		Roller	Spring	Side mounted		0,46	VA15-LRS

Dimensions

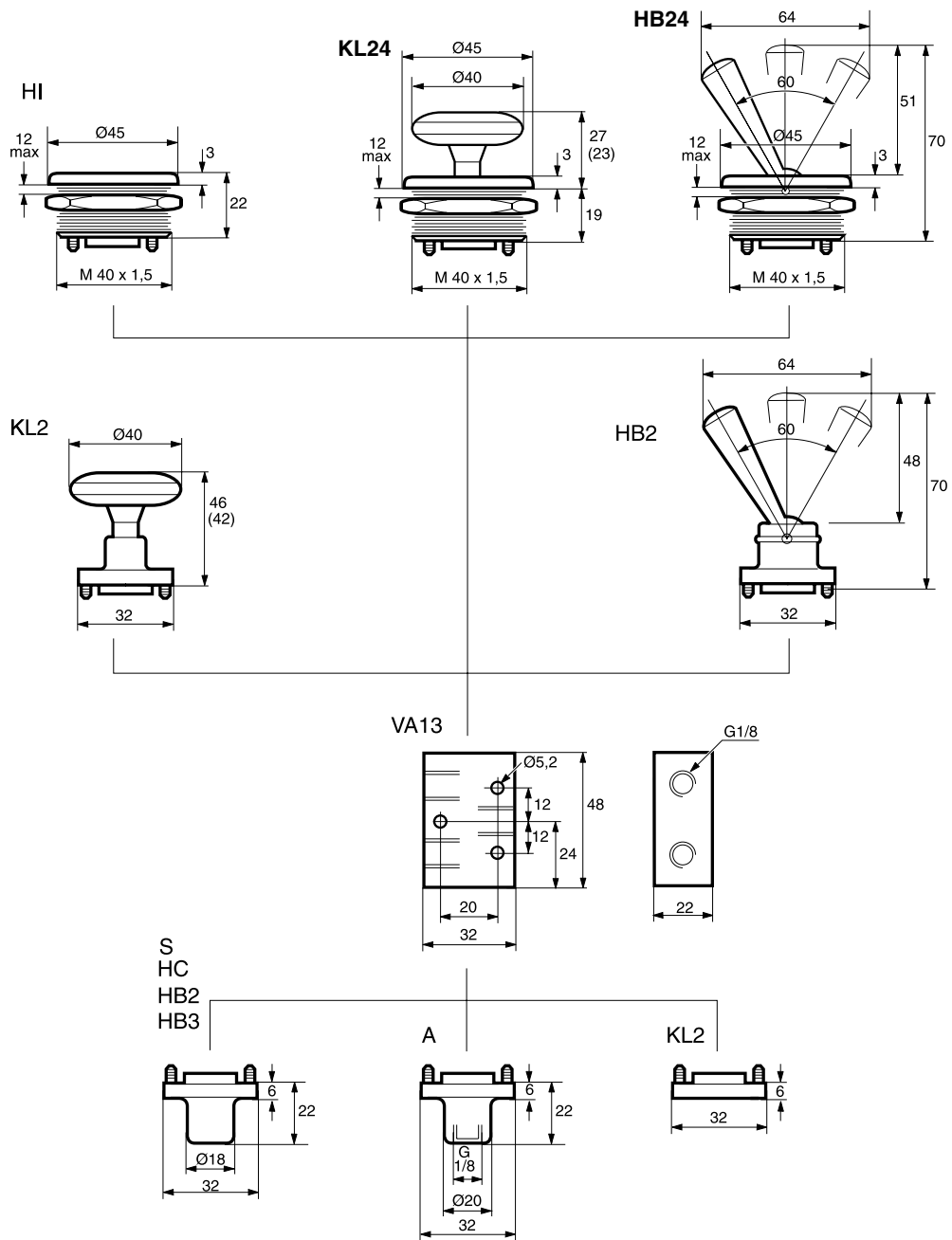

Dimensions

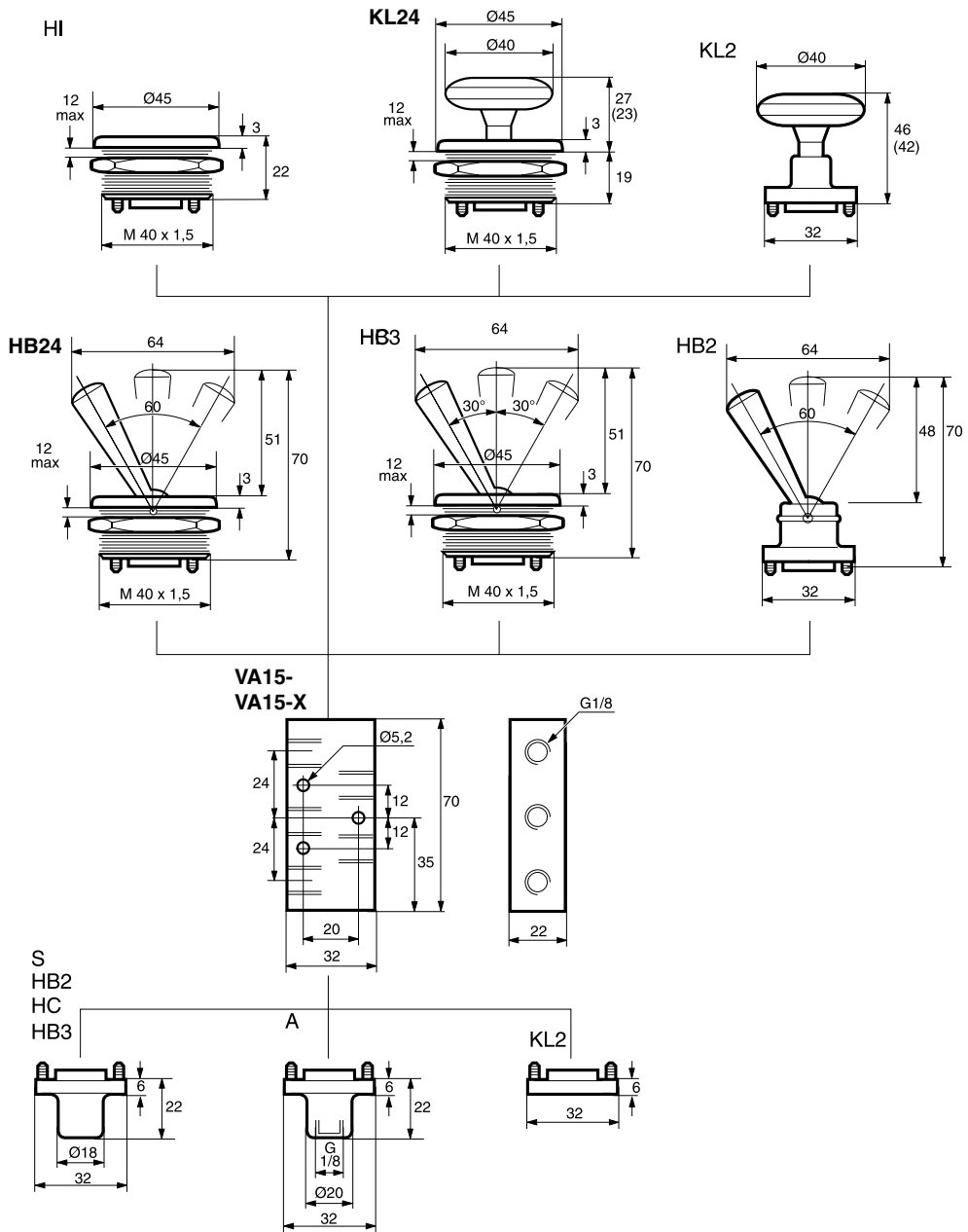

Dimensions

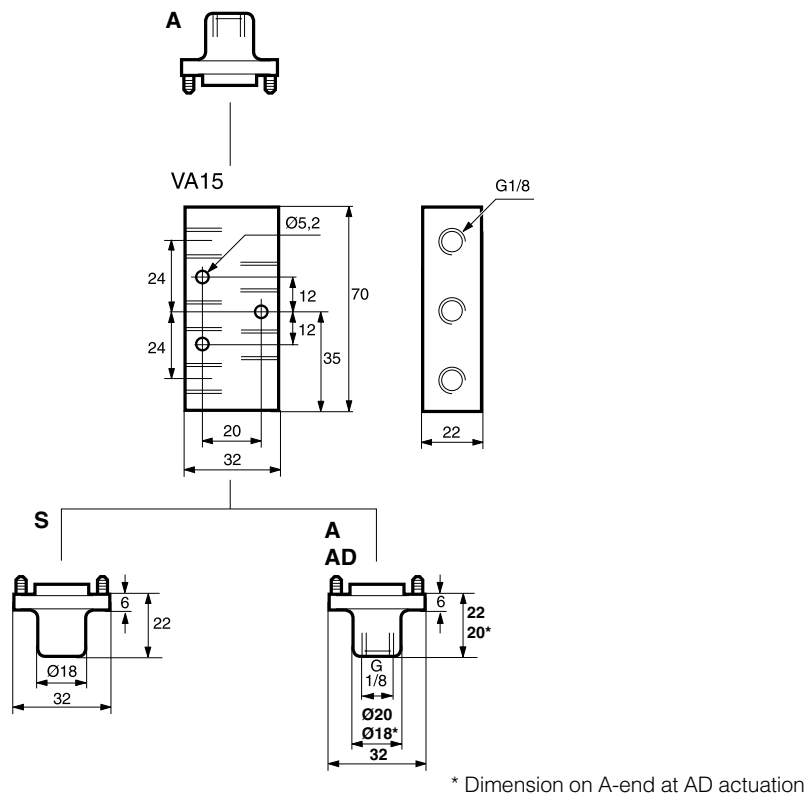
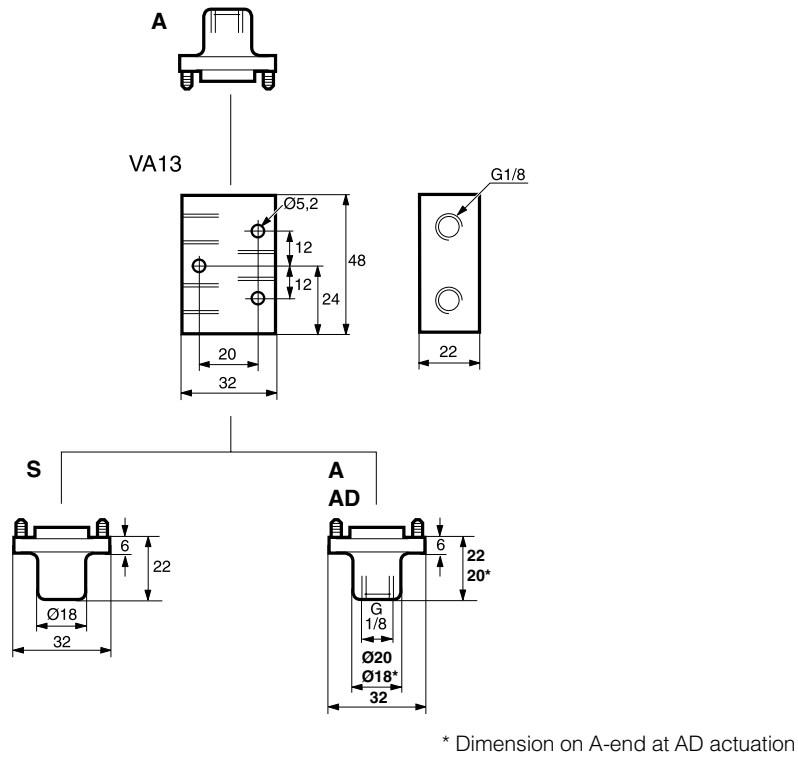

Dimensions

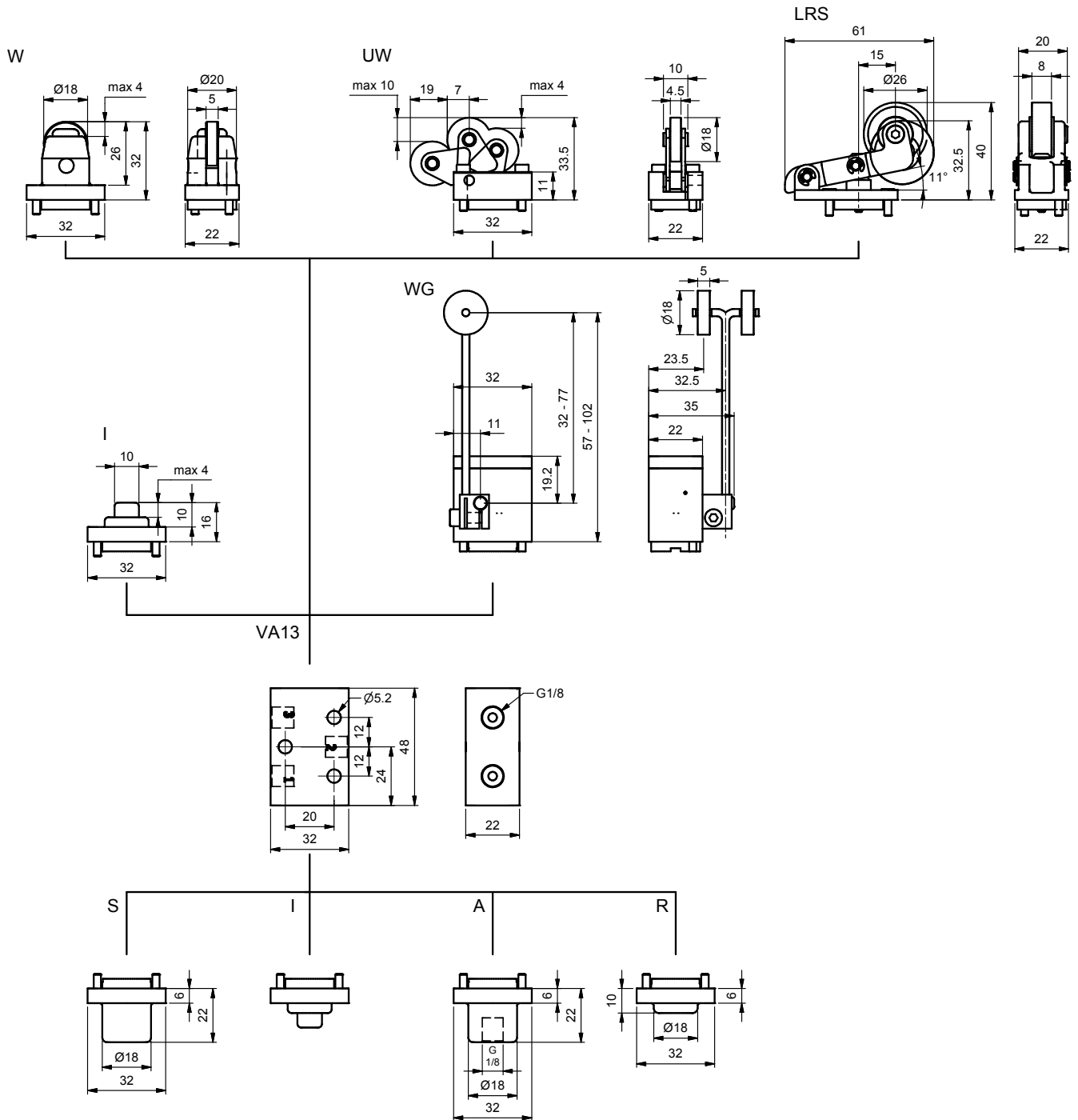

Dimensions

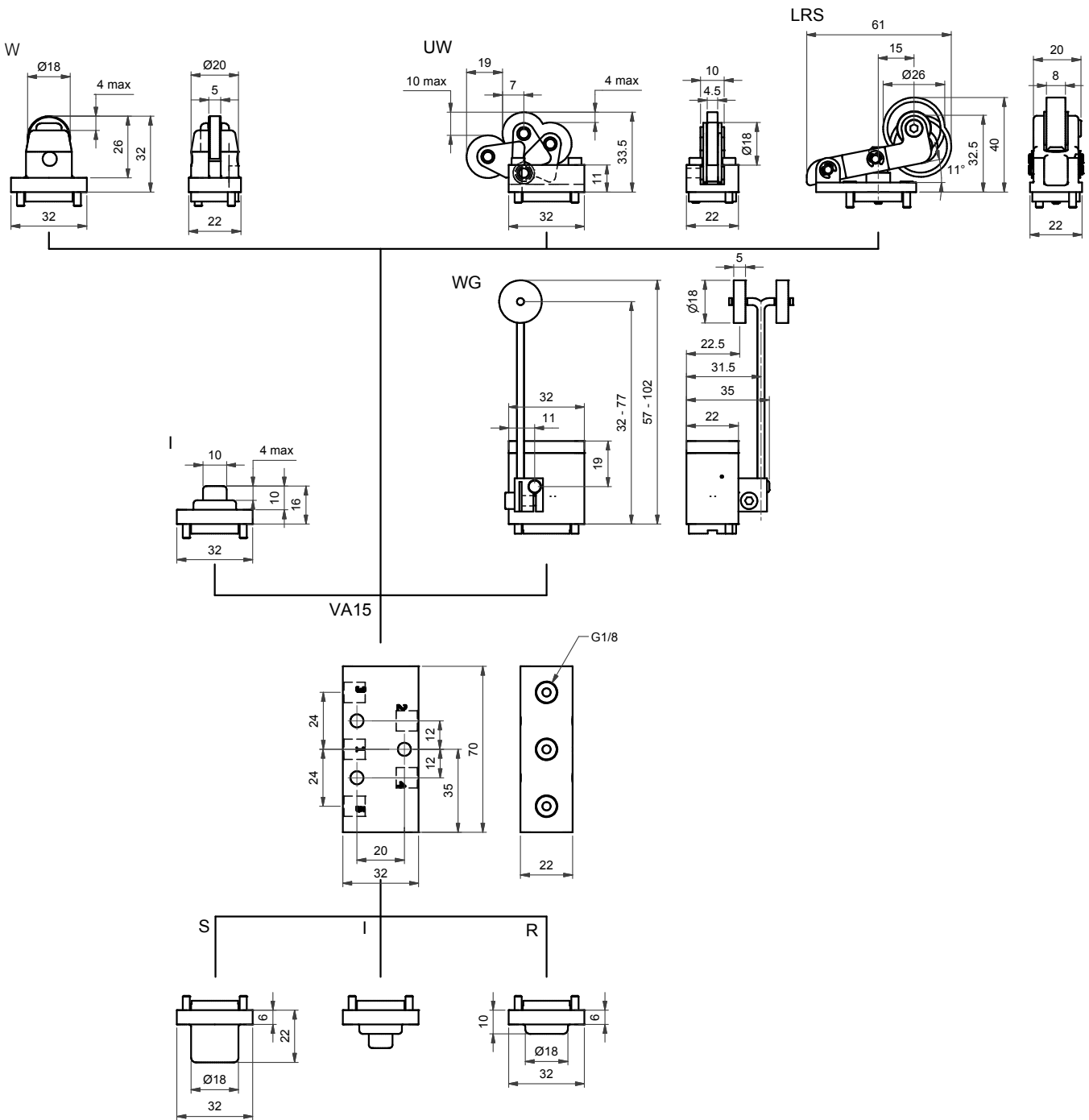

Accessories

Sintered bronze series

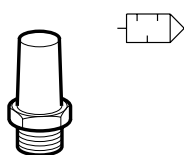

Port	Order code	Pack Qty
G1/8	9090050700	1

Male straight connectors - Parallel thread

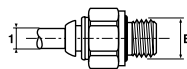

Tube Ø1	Thread B	Order code	Box Qty
4	1/8	F4PMB4-1/8	20
6	1/8	F4PMB6-1/8	30
8	1/8	F4PB8-1/8	40

Service and Replacement Parts

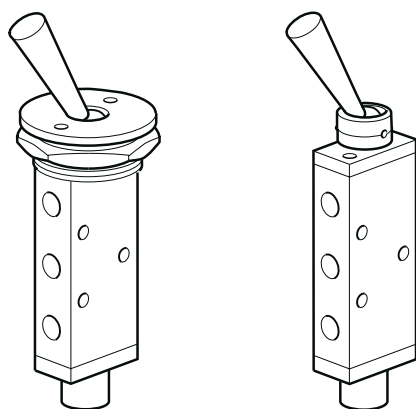

VA Series Heavy Duty Valves

Order code	Repair Kit
9128674100	Body seals (6 pcs. 'O' Ring)



Important !

Before carrying out any service work, ensure that the valve and manifold have been vented. Remove the primary supply air hose to ensure total disconnection of the air supply before dismantling valves or blank connection blocks.



NB !

All technical data in this catalogue is typical only. The air quality is decisive for the valve life: see ISO 8573.



WARNING

FAILURE OR IMPROPER SELECTION OR IMPROPER USE OF THE PRODUCTS AND/OR SYSTEMS DESCRIBED HEREIN OR RELATED ITEMS CAN CAUSE DEATH, PERSONAL INJURY AND PROPERTY DAMAGE. This document and other information from Parker Hannifin Corporation, its subsidiaries and authorized distributors provide product and/or system options for further investigation by users having technical expertise. It is important that you analyze all aspects of your application and review the information concerning the product or system in the current product catalog. Due to the variety of operating conditions and applications for these products or systems, the user, through its own analysis and testing, is solely responsible for making the final selection of the products and systems and assuring that all performance, safety and warning requirements of the application are met. The products described herein, including without limitation, product features, specifications, designs, availability and pricing, are subject to change by Parker Hannifin Corporation and its subsidiaries at any time without notice.

SALE CONDITIONS

The items described in this document are available for sale by Parker Hannifin Corporation, its subsidiaries or its authorized distributors. Any sale contract entered into by Parker will be governed by the provisions stated in Parker's standard terms and conditions of sale (copy available upon request).

Parker Worldwide

AE – UAE, Dubai
Tel: +971 4 8127100
parker.me@parker.com

AR – Argentina, Buenos Aires
Tel: +54 3327 44 4129

AT – Austria, Wiener Neustadt
Tel: +43 (0)2622 23501-0
parker.austria@parker.com

AT – Eastern Europe, Wiener Neustadt
Tel: +43 (0)2622 23501 900
parker.easteurope@parker.com

AU – Australia, Castle Hill
Tel: +61 (0)2-9634 7777

AZ – Azerbaijan, Baku
Tel: +994 50 2233 458
parker.azerbaijan@parker.com

BE/LU – Belgium, Nivelles
Tel: +32 (0)67 280 900
parker.belgium@parker.com

BR – Brazil, Cachoeirinha RS
Tel: +55 51 3470 9144

BY – Belarus, Minsk
Tel: +375 17 209 9399
parker.belarus@parker.com

CA – Canada, Milton, Ontario
Tel: +1 905 693 3000

CH – Switzerland, Etoy
Tel: +41 (0) 21 821 02 30
parker.switzerland@parker.com

CL – Chile, Santiago
Tel: +56 2 623 1216

CN – China, Shanghai
Tel: +86 21 5031 2525

CZ – Czech Republic, Klecany
Tel: +420 284 083 111
parker.czechrepublic@parker.com

DE – Germany, Kaarst
Tel: +49 (0)2131 4016 0
parker.germany@parker.com

DK – Denmark, Ballerup
Tel: +45 43 56 04 00
parker.denmark@parker.com

ES – Spain, Madrid
Tel: +34 902 33 00 01
parker.spain@parker.com

FI – Finland, Vantaa
Tel: +358 (0)20 753 2500
parker.finland@parker.com

FR – France, Contamine s/Arve
Tel: +33 (0)4 50 25 80 25
parker.france@parker.com

GR – Greece, Athens
Tel: +30 210 933 6450
parker.greece@parker.com

HK – Hong Kong
Tel: +852 2428 8008

HU – Hungary, Budapest
Tel: +36 1 220 4155
parker.hungary@parker.com

IE – Ireland, Dublin
Tel: +353 (0)1 466 6370
parker.ireland@parker.com

IN – India, Mumbai
Tel: +91 22 6513 7081-85

IT – Italy, Corsico (MI)
Tel: +39 02 45 19 21
parker.italy@parker.com

JP – Japan, Tokyo
Tel: +(81) 3 6408 3901

KR – South Korea, Seoul
Tel: +82 2 559 0400

KZ – Kazakhstan, Almaty
Tel: +7 7272 505 800
parker.easteurope@parker.com

LV – Latvia, Riga
Tel: +371 6 745 2601
parker.latvia@parker.com

MX – Mexico, Apodaca
Tel: +52 81 8156 6000

MY – Malaysia, Shah Alam
Tel: +60 3 7849 0800

NL – The Netherlands, Oldenzaal
Tel: +31 (0)541 585 000
parker.nl@parker.com

NO – Norway, Ski
Tel: +47 64 91 10 00
parker.norway@parker.com

NZ – New Zealand, Mt Wellington
Tel: +64 9 574 1744

PL – Poland, Warsaw
Tel: +48 (0)22 573 24 00
parker.poland@parker.com

PT – Portugal, Leca da Palmeira
Tel: +351 22 999 7360
parker.portugal@parker.com

RO – Romania, Bucharest
Tel: +40 21 252 1382
parker.romania@parker.com

RU – Russia, Moscow
Tel: +7 495 645-2156
parker.russia@parker.com

SE – Sweden, Spånga
Tel: +46 (0)8 59 79 50 00
parker.sweden@parker.com

SG – Singapore
Tel: +65 6887 6300

SK – Slovakia, Banská Bystrica
Tel: +421 484 162 252
parker.slovakia@parker.com

SL – Slovenia, Novo Mesto
Tel: +386 7 337 6650
parker.slovenia@parker.com

TH – Thailand, Bangkok
Tel: +662 717 8140

TR – Turkey, Istanbul
Tel: +90 216 4997081
parker.turkey@parker.com

TW – Taiwan, Taipei
Tel: +886 2 2298 8987

UA – Ukraine, Kiev
Tel: +380 44 494 2731
parker.ukraine@parker.com

UK – United Kingdom, Warwick
Tel: +44 (0)1926 317 878
parker.uk@parker.com

US – USA, Cleveland
Tel: +1 216 896 3000

VE – Venezuela, Caracas
Tel: +58 212 238 5422

ZA – South Africa, Kempton Park
Tel: +27 (0)11 961 0700
parker.southafrica@parker.com

European Product Information Centre

Free phone: 00 800 27 27 5374

(from AT, BE, CH, CZ, DE, DK, ES, FI, FR, IE, IT, NL, NO, PL, PT, RU, SE, UK, ZA)



Parker Hannifin Ltd

Pneumatic Division Europe
The Collins Centre,
Lichfield South, Wall Island,
Birmingham Road, Lichfield.
WS14 0QP United Kingdom
Tel.: +44 (0) 1543 483800
Fax: +44 (0) 1543 483801
www.parker.com/euro_pneumatic